

CENTRAL ELECTRONICS, INCORPORATED
5801 W. DICKENS AVENUE
CHICAGO, ILLINOIS 60639

100V - 200V ALIGNMENT INSTRUCTIONS AND GENERAL SERVICE INFORMATION

ATTENTION! BE SURE TO READ PARAGRAPH 12 BEFORE CONSIDERING ALIGNMENT.

I. The following equipment will be required for alignment.

- a. OSCILLOSCOPE
- b. 100 WATT, 52 OHM OUTPUT LOAD RESISTOR. Must be non-reactive to 30 mc.
- c. RF SWEEP GENERATOR. Band edge markers will be required at the following frequencies:

80 meters - 3.5 and 4.5 mc.	15 meters - 20.5 and 21.5 mc.
40 meters - 6.5 and 7.5 mc.	10 meters - 27.7 and 29.7 mc.
20 meters - 13.5 and 14.5 mc.	VFO - 5.0 and 6.0 mc.
	1st Mixer - 13 mc and 14 mc.

d. DETECTOR PROBE.

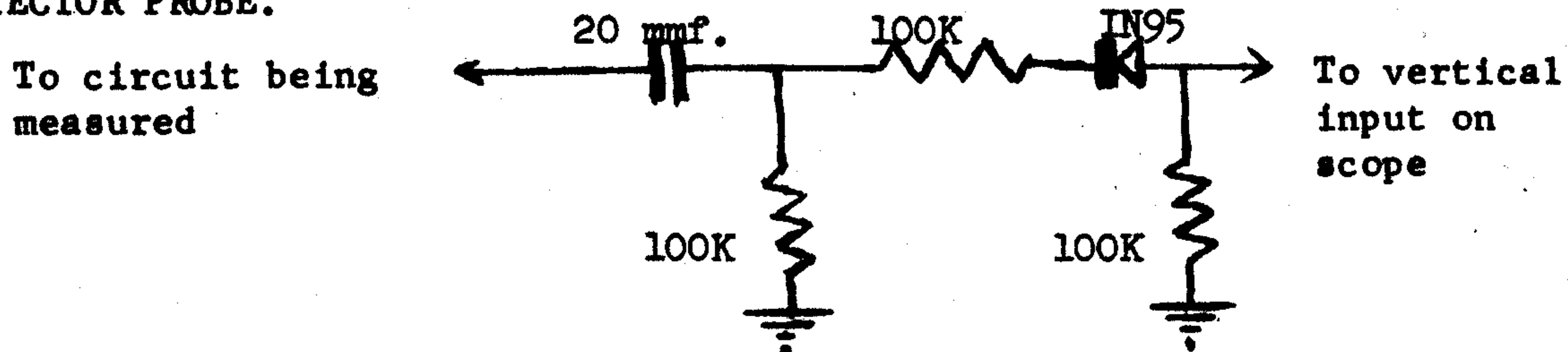

e. SWEEP PROBE.

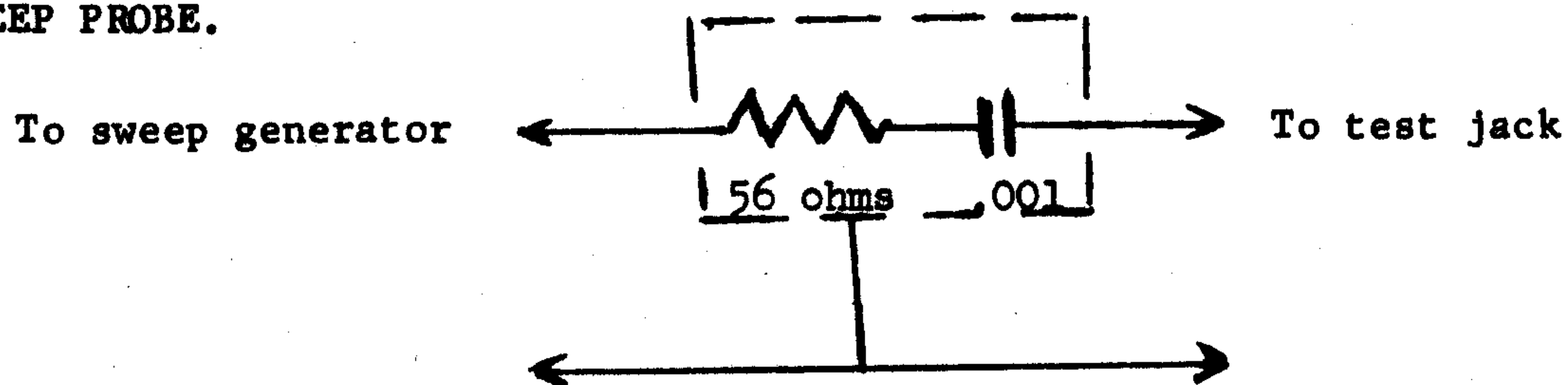

f. GENERAL CEMENT #8606 TV ALIGNMENT TOOL.

II. Place the switches in the following positions:

- VFO-XTAL - in XTAL position.
- EMISSION - in CW position.
- FUNCTION - in MANUAL position.

III. Unless the alignment has been tampered with previously, the adjustments should not require more than $\frac{1}{2}$ turn.

During alignment, be sure to keep sweep generator below the flat-topping level at all times.

IV. DRIVER COIL ALIGNMENT.

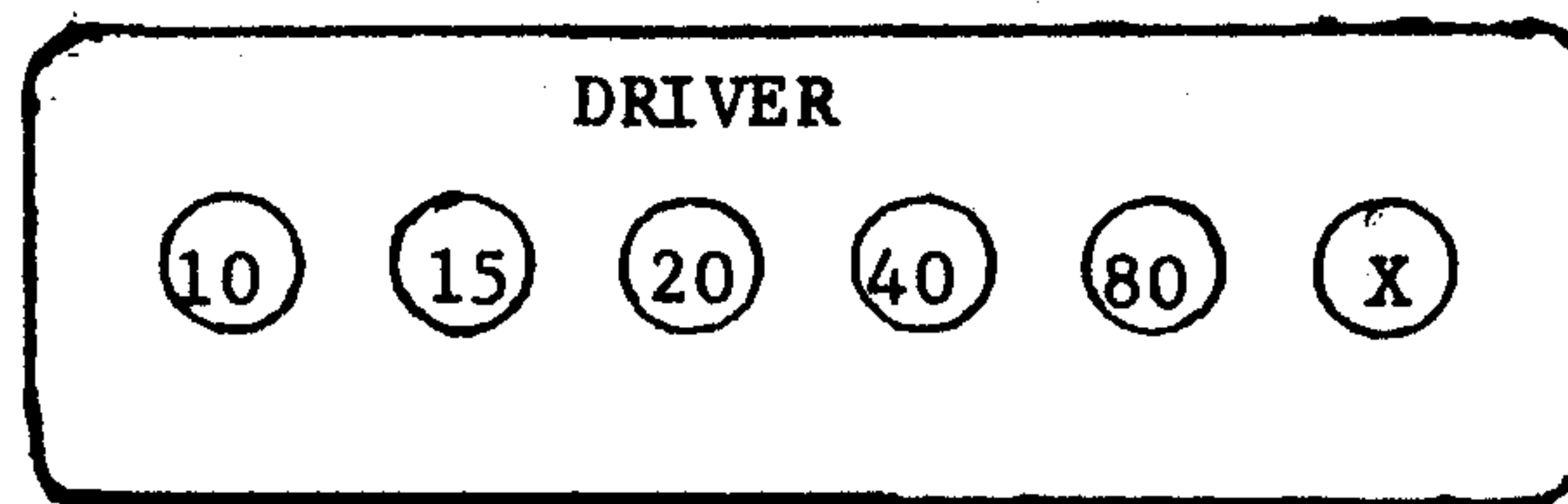

- a. Remove 2nd Mixer coil assembly.
- b. Place sweep probe into test point "G" of Driver tube, with grounded side to chassis.
- c. Place detector probe on output load resistor.
- d. Set bandswitch to 80 meters.
- e. Adjust sweep generator to cover 3.5 to 4.5 mc., with markers at these two points. Adjust the two 80 meter cores to obtain reasonably flat response across the entire 1 mc. range, consistent with maximum output.
- f. Adjust 40, 20, 15 and 10 meters in the same manner, with band edge markers as described in I c.
- g. Typical driver waveform:

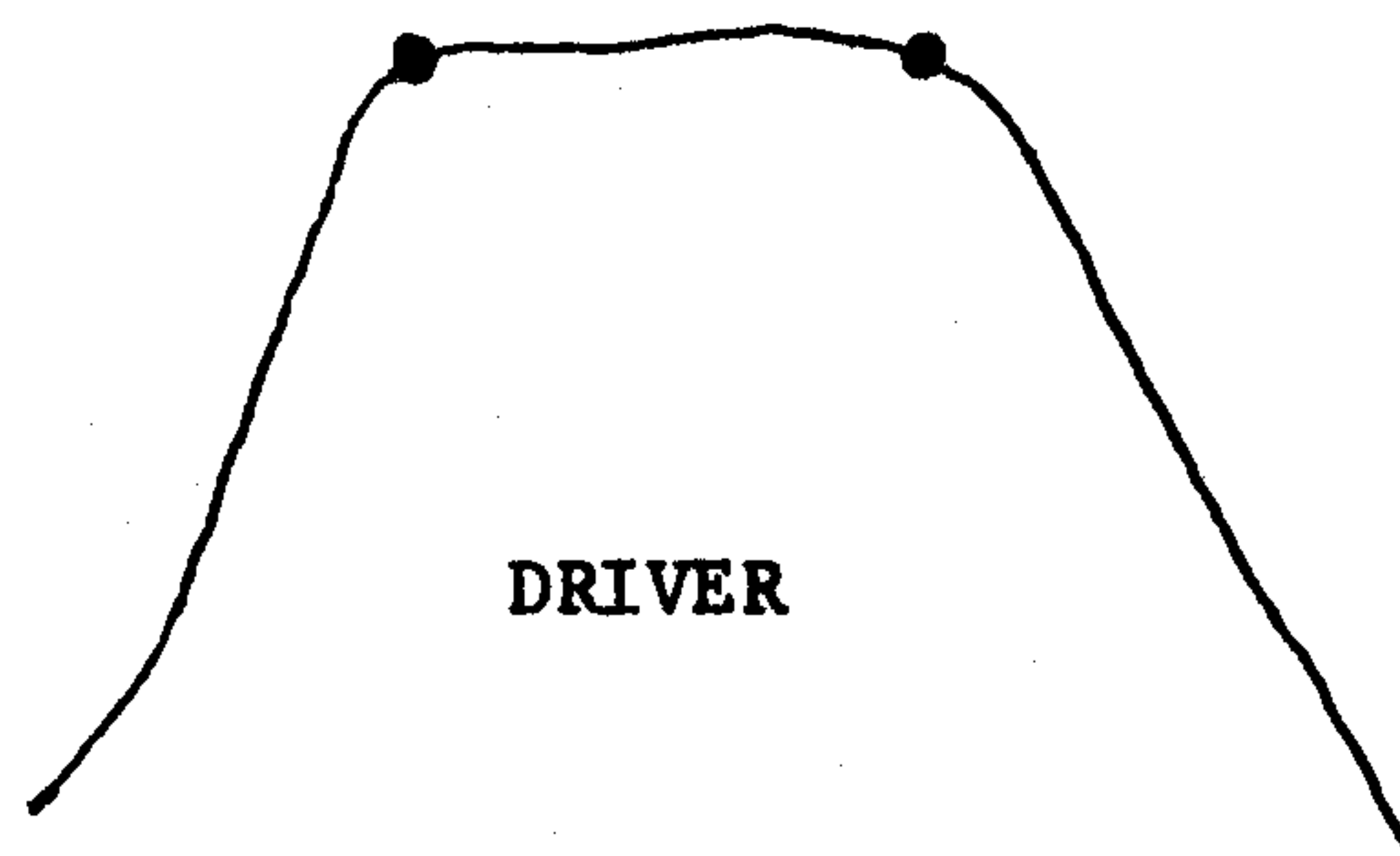

V.

2ND MIXER ALIGNMENT

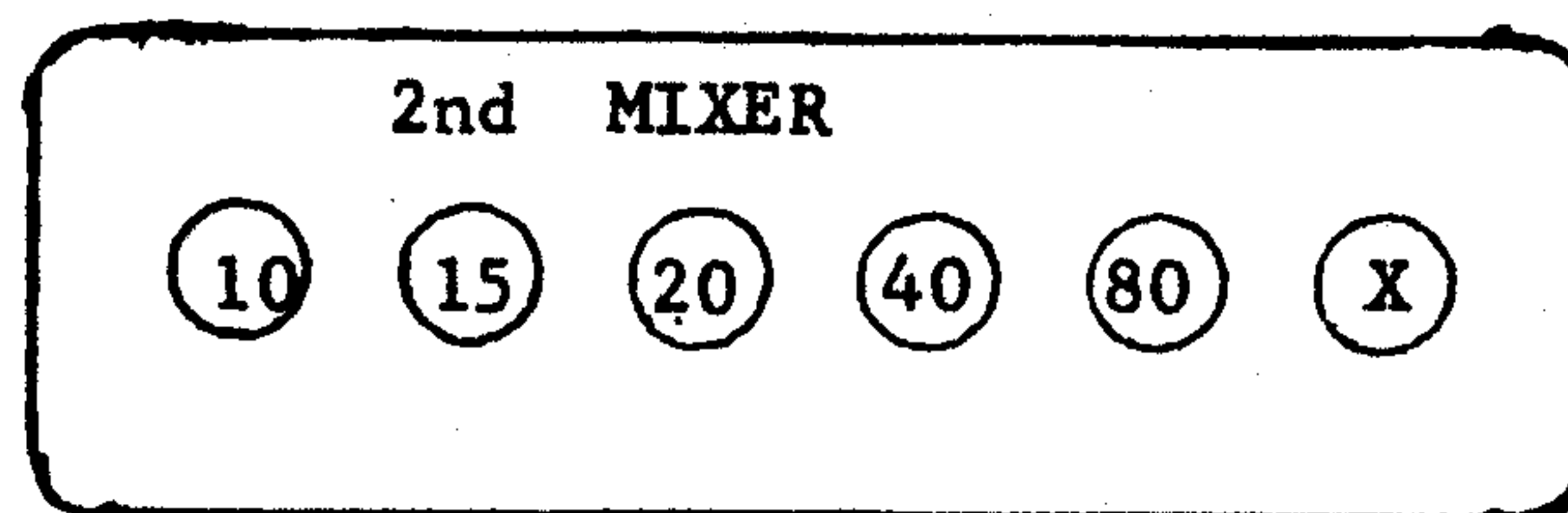

- a. Install 2nd Mixer coil assembly.
- b. Insert probe into test point "G" of 2nd Mixer tube, with ground to chassis.
- c. Align 15, 40 and 80 meters for reasonably flat response, using frequencies the same as in Driver alignment.
- d. Place probe into test point "K" of 2nd Mixer tube and align 10 and 20 meters for flat response, using frequencies the same as in Driver alignment.

e. Typical 2nd Mixer waveform:

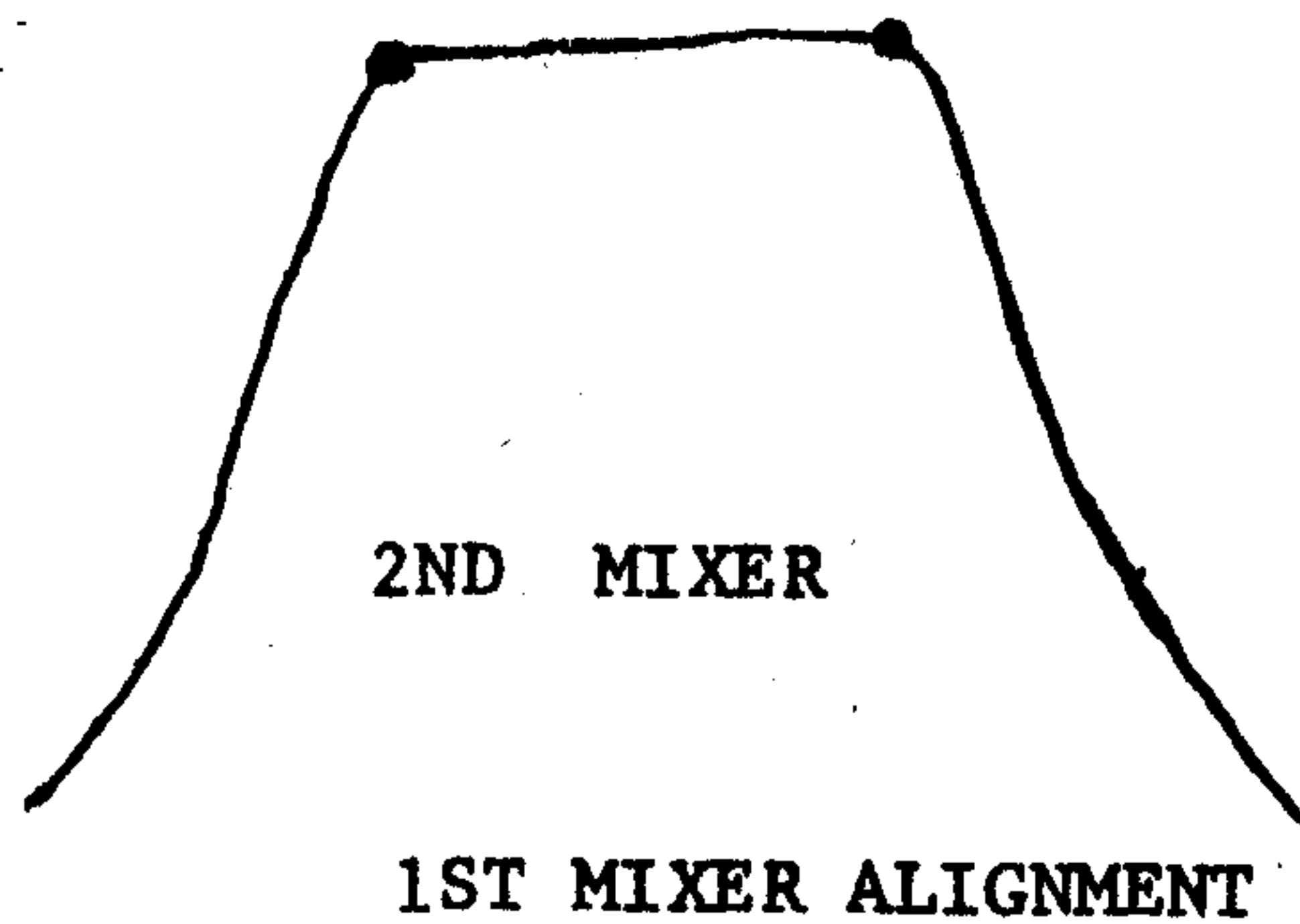

VI.

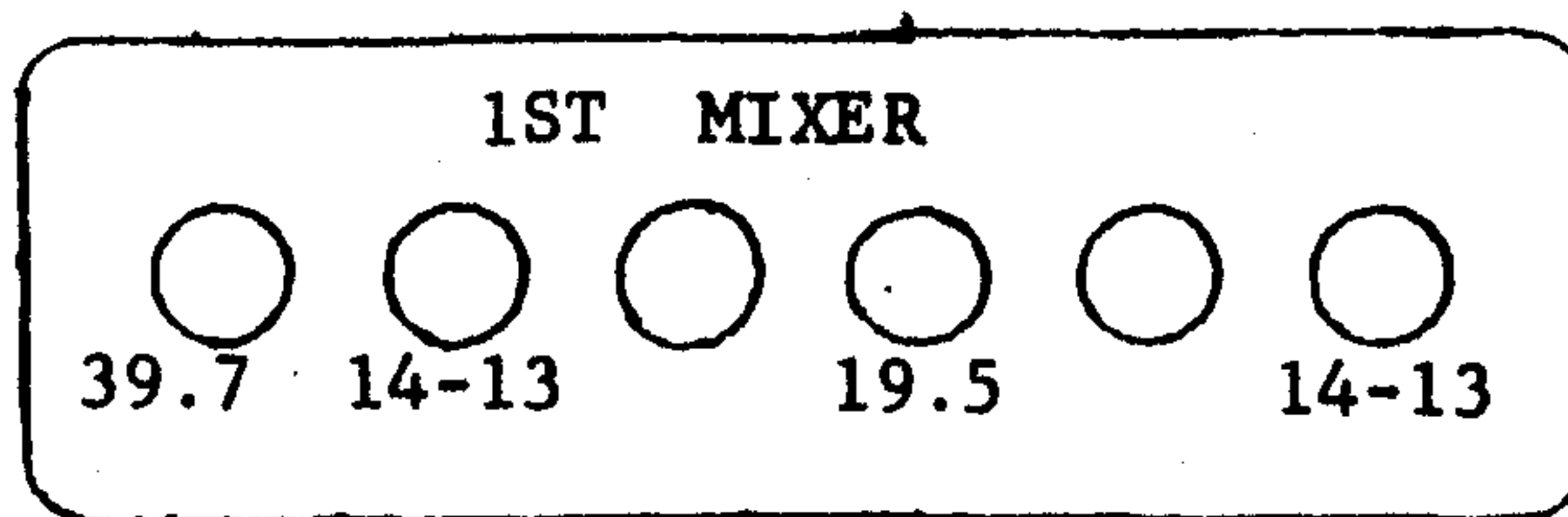

- a. Remove detector probe from output load resistor and place it into test point "K" of 2nd Mixer tube, with grounded side to chassis.
- b. Put sweep probe into test point "G" of 1st Mixer tube, with grounded side to chassis.
- c. Adjust sweep generator for 14-13 mc., with markers at these two points.
- d. Place bandswitch in the 15 meter position.
- e. Adjust the two 14-13 mc. coils (four tuned circuits) for best flat response.
- f. Place bandswitch in the 10 meter position.
- g. Set generator to 39.7 mc, fixed frequency.
- h. Adjust the two 39.7 mc. tuned circuits for maximum output.
- i. Place bandswitch on 20 meters.
- j. Set generator to 19.5 mc., fixed frequency.
- k. Adjust the two 19.5 mc. tuned circuits for maximum output.
- l. NOTE! After the entire alignment procedure has been completed, the 39.7 mc. adjustment for 10 meters and the 19.5 mc. adjustment for 10 meters may be detuned to equalize the RF gain on 10 and 20 meters with respect to the other three bands.
- m. Typical 14-13 mc. 1st Mixer waveform:

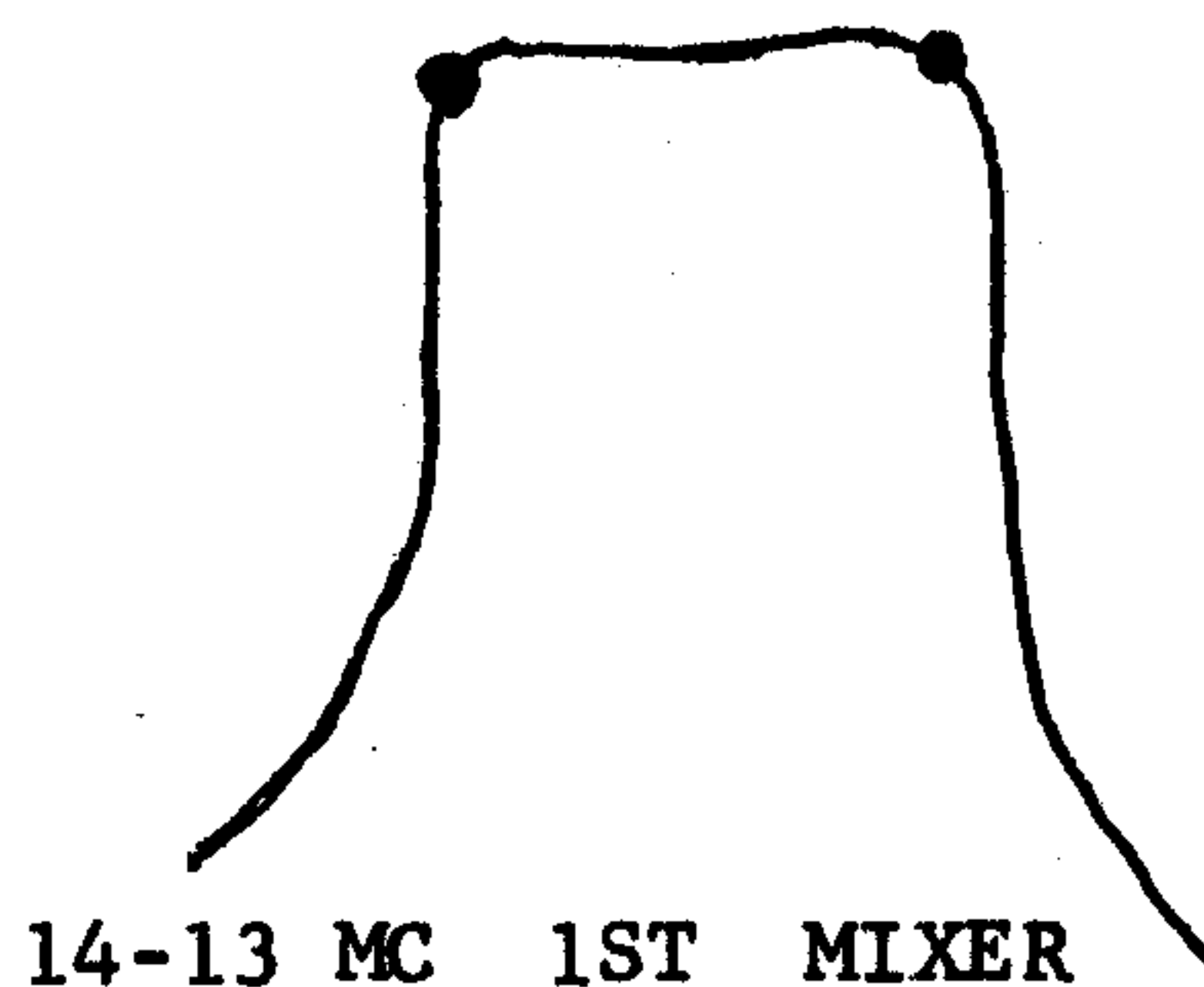

VII.

12-10 MC. BUFFER-DOUBLER ALIGNMENT

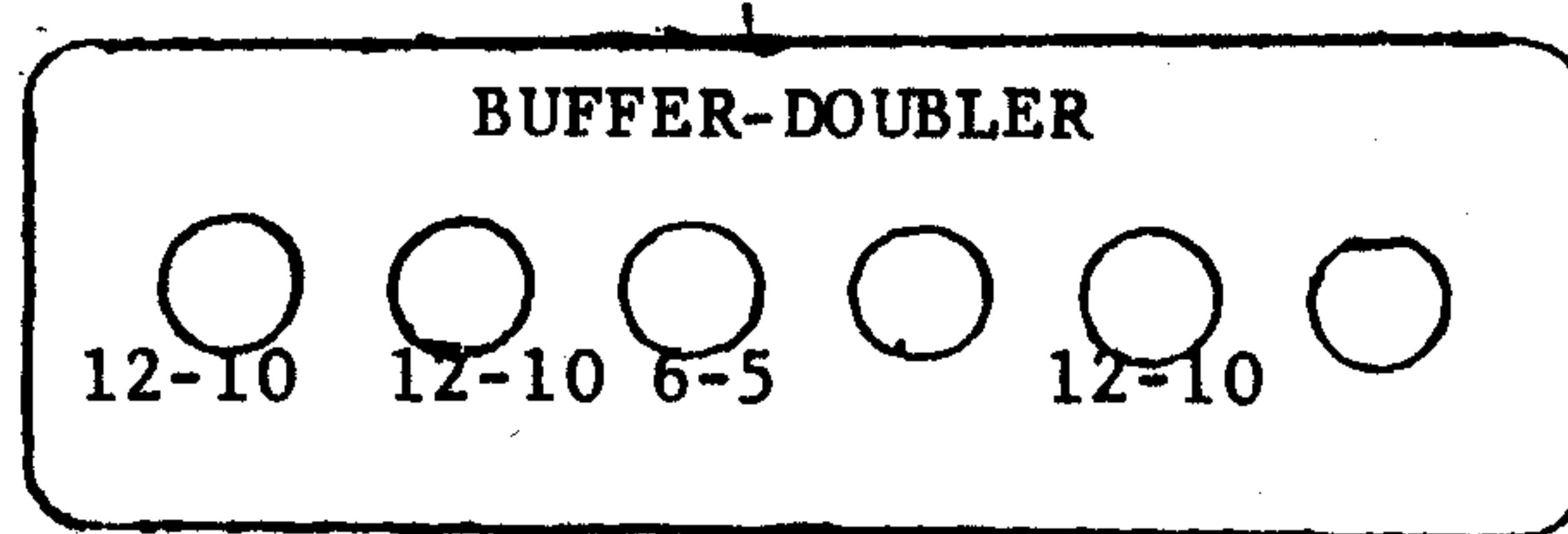

- a. Turn VFO-XTAL switch to VFO.
- b. Place bandswitch on 10 meters.
- c. With detector probe still in test point "K" of 2nd Mixer, move sweep probe test point to "G" of the Buffer-Doubler tube.
- d. Adjust sweep generator to cover 10-12 mc. with markers at these two points.
- e. Adjust the three 12-10 mc. coils (6 tuned circuits) for best flat response at maximum gain. Early 100V's have only four tuned circuits.
- f. Typical 12-10 mc. waveform:

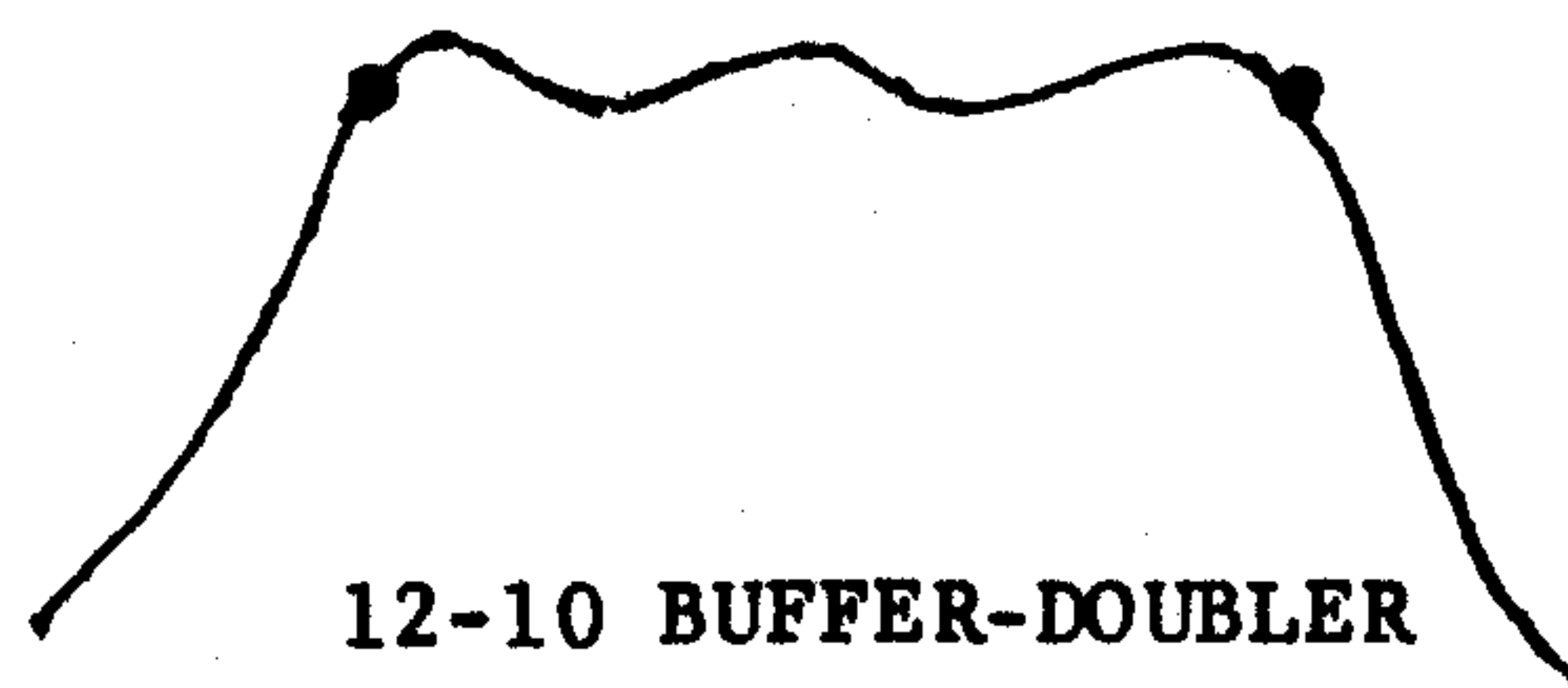

VIII. ALIGNMENT OF VFO INPUT COIL AND 6-5 MC. BUFFER DOUBLER

- a. Disconnect the VFO-OUT VFO-IN coaxial jumper on the rear of the chassis.
- b. Remove the sweep probe from test point "G" of the Buffer-Doubler tube, and connect to the VFO INPUT jack.
- c. Adjust the sweep generator to 5 to 6 mc., with markers at these two points.
- d. Tune VFO INPUT coil for best flat response. The VFO INPUT coil is the 1" square can in front of the BUFFER-DOUBLER coil.
- e. Move bandswitch to 20 meters.
- f. Still feeding 5 to 6 mc. to the VFO INPUT jack, tune the 6-5 mc. coil (two adjustments) in the BUFFER-DOUBLER for best flat response.
- g. Typical 6-5 mc. BUFFER-DOUBLER pattern:

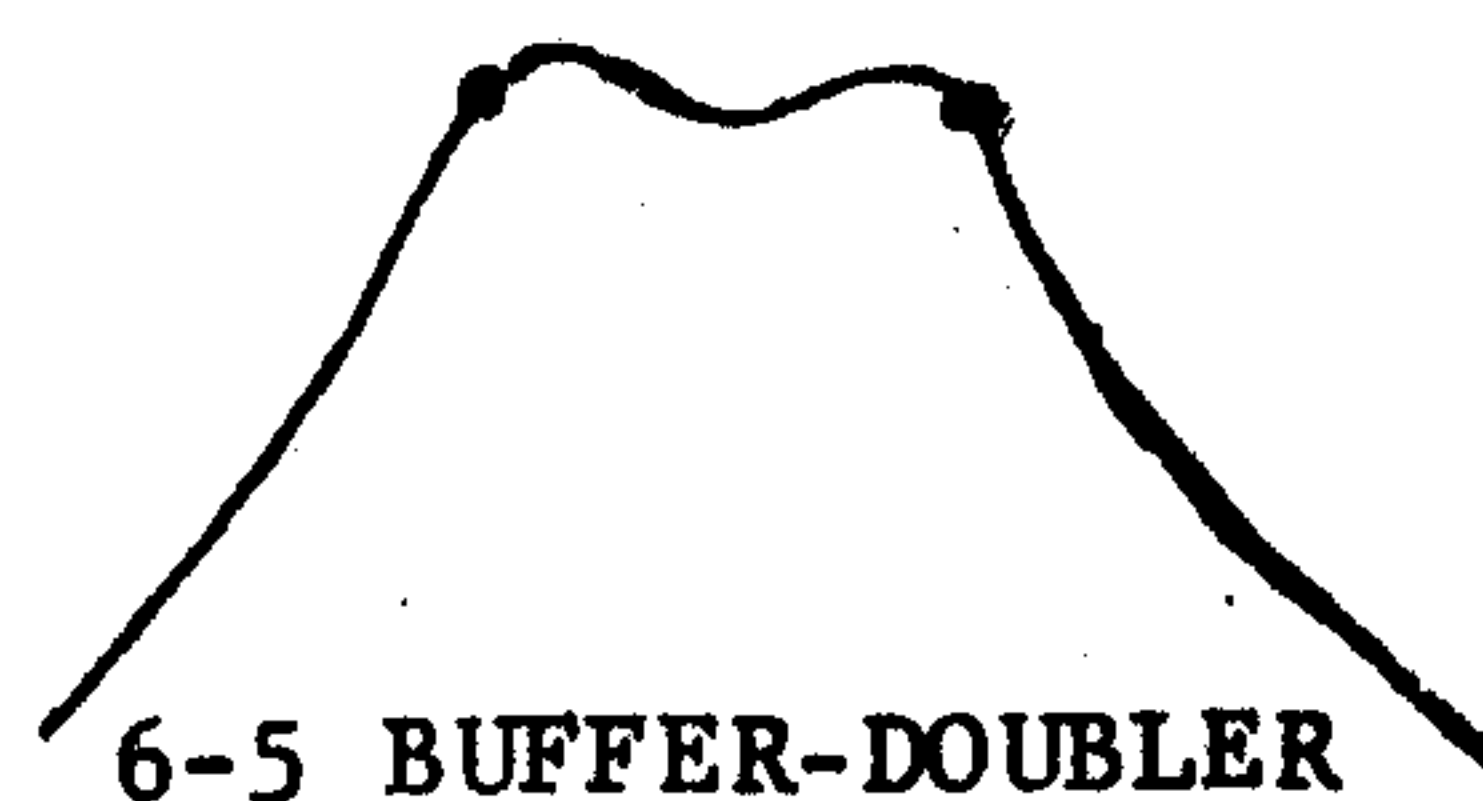

- h. Remove sweep generator probe from VFO INPUT jack and replace the VFO INPUT - VFO OUTPUT jumper cable.

IX. ALIGNMENT OF THE VFO OUTPUT COIL

- a. Set bandswitch to 10 meters.
- b. With the sweep generator still in the 5-6 mc. position, place the sweep probe into the test jack in the upper left hand corner of the VFO.
- c. Remove the tube from the right hand socket of the VFO (6U8 or 6BL8).
- d. Place detector probe on test point "K" of 2nd mixer tube.
- e. The VFO OUTPUT coil is accessible by removing the $\frac{1}{2}$ " diameter plug button directly above the two VFO tube sockets.
- f. Adjust the VFO OUTPUT coil for best flat response.

X. CHECKING OVERALL BROAD-BAND RESPONSE

- a. Leave sweep generator same as IX b.
- b. Leave tube out of VFO, same as IX c.
- c. Rotate bandswitch from band to band to check the response. If necessary, touch up the individual coils. Keep in mind that the 14-13 mc. 1st Mixer coils are common to 80, 40 and 15 meters only, and will affect these three bands simultaneously. The 12-10 mc. doubler is in use on 10 meters only.

XI. HIGH FREQUENCY CRYSTAL OSCILLATOR COILS

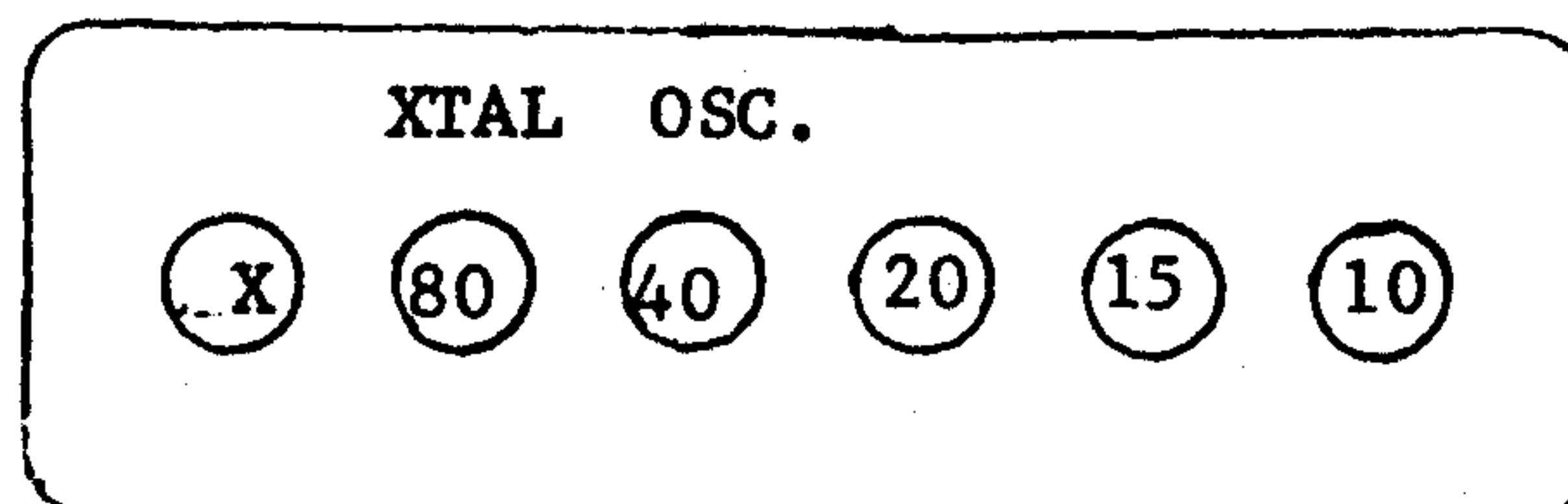

The high frequency crystal oscillator plate tuning coils should all be peaked for maximum output, consistent with proper calibration. If these are detuned too far to obtain exact calibration, the power output may drop, or the crystals may not oscillate reliably.

The tuned circuits are subject to aging, and will require re-peaking on units that have been out in the field. Symptoms will be the lack of reliable oscillation and drop in power as stated previously, or one or more bands will be dead altogether. Be sure that the high frequency crystal oscillator tube is in good condition. These coils should be peaked with the tube shield in place since the capacitance of the shield has considerable effect on the tuning.

XII. GENERAL SERVICE INFORMATION (RF)

Only a very few units will require complete realignment. Due to the fact that most of the circuits (other than the high frequency crystal oscillator plate coils) are low Q, overcoupled and heavily loaded, they are not as critical as the sharply tuned undercoupled circuits commonly found in receiver IF circuits.

Approximately 90% of those units returned to the factory for "alignment" require no alignment whatsoever, unless the owner has attempted alignment without suitable equipment.

The overall RF gain from the balanced modulator to the output stage can be determined without elaborate test equipment. With a 50 ohm 100 watt non-reactive load resistor connected to the output, place the Emission switch in CW position, the CW Carrier control at 12 o'clock and advance the Power Output control to maximum. In the Manual position the power input should be 150 to 180 watts on all bands.

Most units can be brought to standard power output by the following procedure:

1. Peak the HF XTAL OSC plate tuning cores as described in Chapter XI.
2. Check all tubes in the RF section, and VFO. If possible use a good tube checker. If no tube checker is available do not try replacing one tube at a time to see if the power increases. If several tubes are slightly weak, changing only one tube will have little effect unless it is very weak.
3. Check resting plate current, without drive, on the 6BQ5 driver stage. Use a DC voltmeter, 1000 ohms per volt or higher. This should measure .36 volts DC at the Driver "K" test point to ground, with a good tube. On 100V's, it will be necessary to change the ratio of the bias divider resistor for this stage. On the 200V, there is a bias adjustment potentiometer on the right lip of the chassis.
4. On 100V's, try several different 12BY7 mixer tubes, and be sure to adjust the spurious radiation potentiometers with each tube. On some 12BY7 tubes, the power output will be low at the point where the spurious radiation is at minimum. It will be necessary to select a tube that has good power output at the point where the spurious signal reaches a null.
5. On 100V's, there may be poor contact between the pins of the rectangular plugin coil cans, and the socket clips. On units where the power output is low, or drops appreciably after a short period of time, try rocking the cans gently to see if the power output increases. If so, it will be necessary to remove the coil and increase the contact pressure on the socket clips.

6. On 100V's the power output on 10 meters may be low after adding the spurious radiation potentiometers. Power output may be restored to normal by using a higher "Q" 39.7 mc. 1st Mixer coil, the same as used in the 200V. The old windings may be removed and new ones made with #20 enameled wire. The primary consists of 9 turns, close wound, with no shunt capacitance. The secondary has 12 turns, close wound with 5 mmf. shunt capacitance. Spacing between the coils is 3/8". Just peak for maximum drive on 10 meters.

XIII. GENERAL SERVICE INFORMATION (AF)

a. AUDIO LIMITER MAINTENANCE

Be sure to change batteries at least once each year. The 6 mfd. 50V electrolytic capacitors originally used in the equipment are subject to a high rate of failure. These are the units enclosed in a white ceramic case, which will usually go "open", both physically and electrically.

In areas where high humidity prevails, it has sometimes been noted that the Audio Limiter requires about 20 minutes to a half hour to reach standard output. Touching a 100 watt soldering iron to the edge of the printed circuit board in the vicinity of the batteries and diodes for a minute or two will restore the unit to full output for a few minutes. This effect can be eliminated by removing the printed circuit wiring from the board that is associated with the batteries and diodes. Remove the batteries and diodes, and enlarge the diode holes so that the leads will not make intimate contact with the board. Solder the batteries and diodes together with their own leads.

b. SIDEBAND SUPPRESSION

Poor sideband suppression is generally caused by "open" 6 mfd. 50V electrolytic capacitors in the plug-in MOD CAPS assembly.

If the modulator capacitors appear to be good, remove the PS-2 and take off the cover. Using a long nose pliers, gently pull on the leads from the mica capacitors that go to the board. During the original soldering process, the hot wax from the capacitor case will run down the wire leads to the board, and result in a poor connection.

This treatment should also be applied to the leads that go into the 9 prong plug to see that the connections are properly soldered.

Early 100V's used 3900 ohm, 1 watt, 5% resistors in the plate circuit of V10, the 12BH7, R146 and R149. These are generally located underneath the 12BH7 socket, with one end tied to the center shield. If the case is discolored on the resistors, check their value and replace with 2 watt, 5%, if necessary.

Central Electronics, Incorporated

A subsidiary of Zenith Radio Corporation

AMATEUR — COMMERCIAL — MILITARY — COMMUNICATION EQUIPMENT

1247 W. BELMONT AVENUE • CHICAGO 13, ILLINOIS • ³¹² EA 8161 • 7-7460

March 1, 1961

TO ALL 100V OWNERS:

Our warranty records indicate that you are the owner of a 100V Exciter-Transmitter below serial number 863. If this equipment is no longer in your possession, please forward this letter to the present owner if possible.

100V's below serial number 863 may be transmitting a spurious signal when operating on the 80, 40, and 15 meter bands approximately 40 db down from full output. Although the level of this signal is somewhere in the vicinity of 1.0 or 20 milliwatts, it is possible to sustain communication for several hundred miles with favorable propagation conditions.

By changing the 12BY7 mixer circuits, these products can be reduced to at least -50 db, and usually to -60 or -70 db.

There are basically three categories of 100V's--those without Rheostats in the mixer circuits from serial 1 through 448; those with mixer rheostats from serial 449 through 862; and all units from serial 863 and up that have mixer rheostats and the improved mixer circuits.

Some units below 448 have had mixer rheostats installed at the factory; however, they may still require mixer circuit revision. These can be identified by the shaft of a rheostat protruding from the right side of the chassis below the first mixer plug-in coil unit. Units below serial 863, stamped with the letter "W" following the serial number, have all the latest mixer changes.

Central Electronics, Incorporated is prepared to furnish, at no charge, the necessary components and instructions for performing these modifications. For 100V's below serial 448 that do not have potentiometers installed, you should request 100V Modification Kit "A". For 100V's below serial number 863 with rheostats that do not have the letter "W" stamped next to the serial number, 100V Modification Kit "B" should be requested. Modification Kit "B" only requires one resistor and one rheostat to be changed.

Adjustment of these rheostats is very simple. Merely adjust them while listening to the signal in a receiver, as described in the kit instructions.

AF LIMITER BATTERY & DIODE REPLACEMENT DIAGRAM

CENTRAL ELECTRONICS, INC.

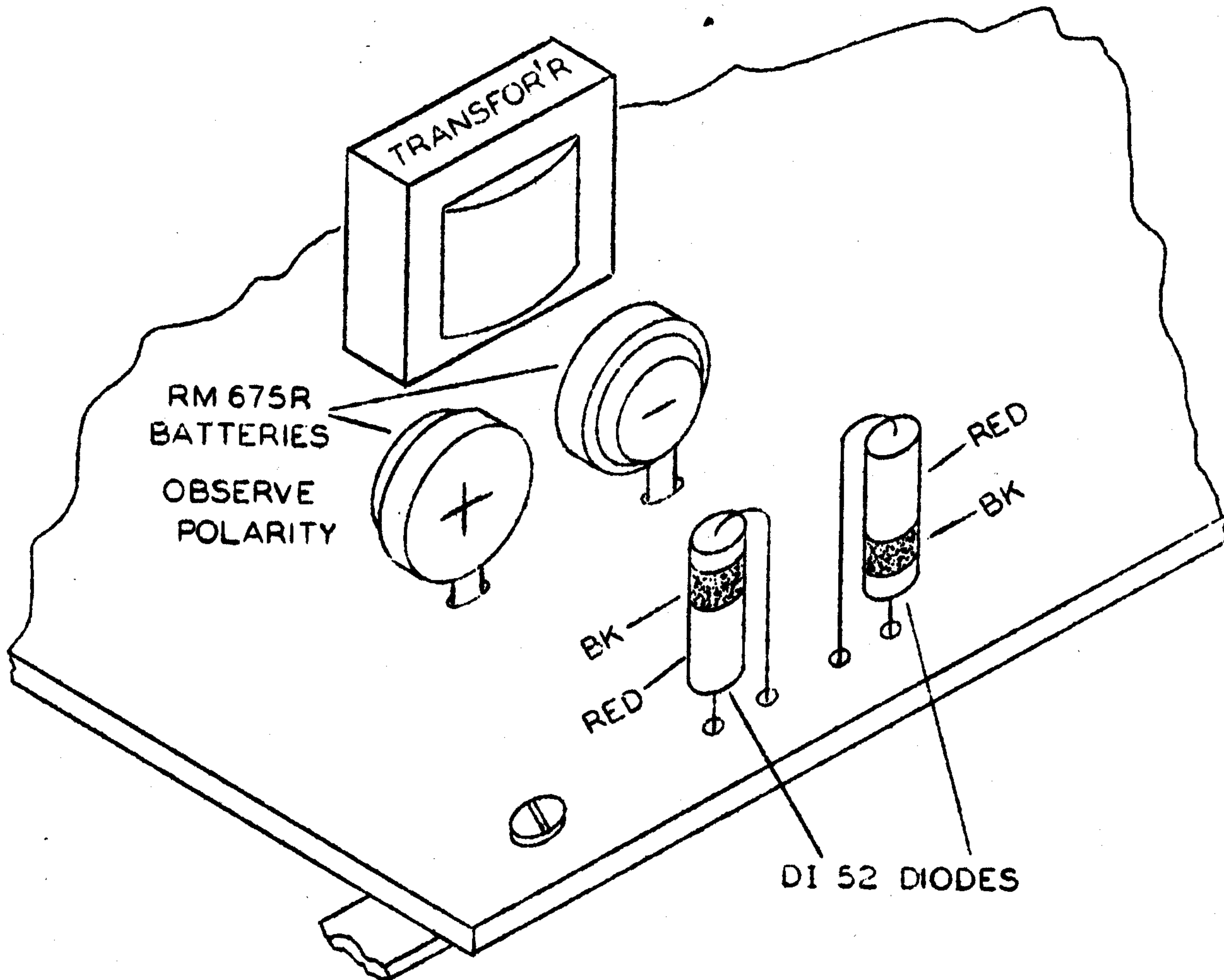

The RM400R batteries formerly used in the 100V audio limiter have been replaced with the RM675R. As you will note in the sketch above, the polarity of the RM675R is opposite to that of the RM400R, shown in the 100V manual. Be careful to install the batteries in the manner shown above.

Most 100V limiters used IN100A germanium diodes, which are now changed to DI-52 silicon type.

M243

6/1/61
Printed in U.S.A.